

PLAN 10

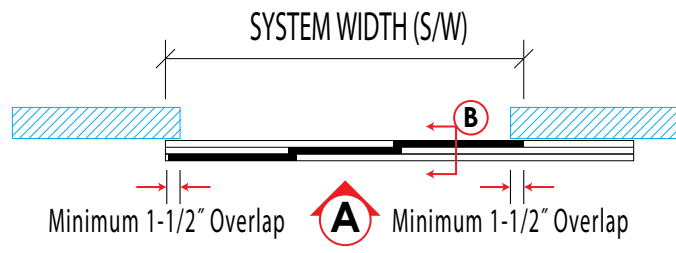

ELEVATION A

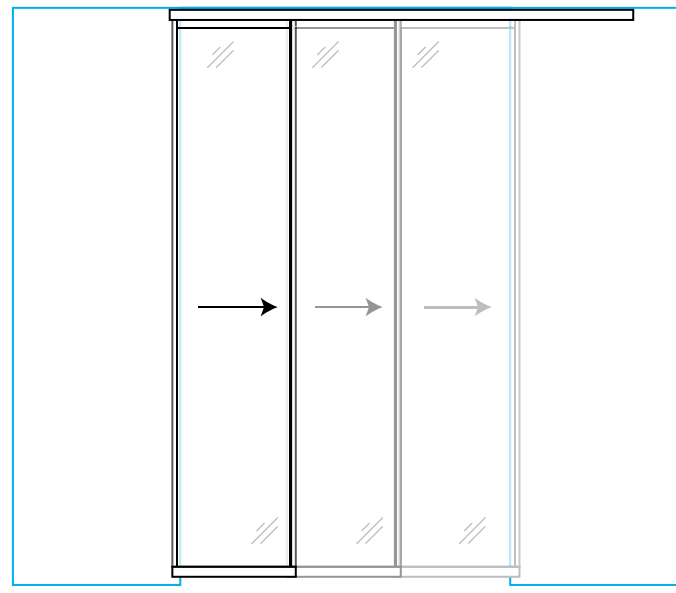

PROJECT:

ARCHITECT:

Riviera
rivieraglassdividers.com

ALLIANCE GLASS DOORS INC.
Surrey, BC, Canada, V3W 1A2
T: 604.501.2588
F: 604.501.1608

SECTION B

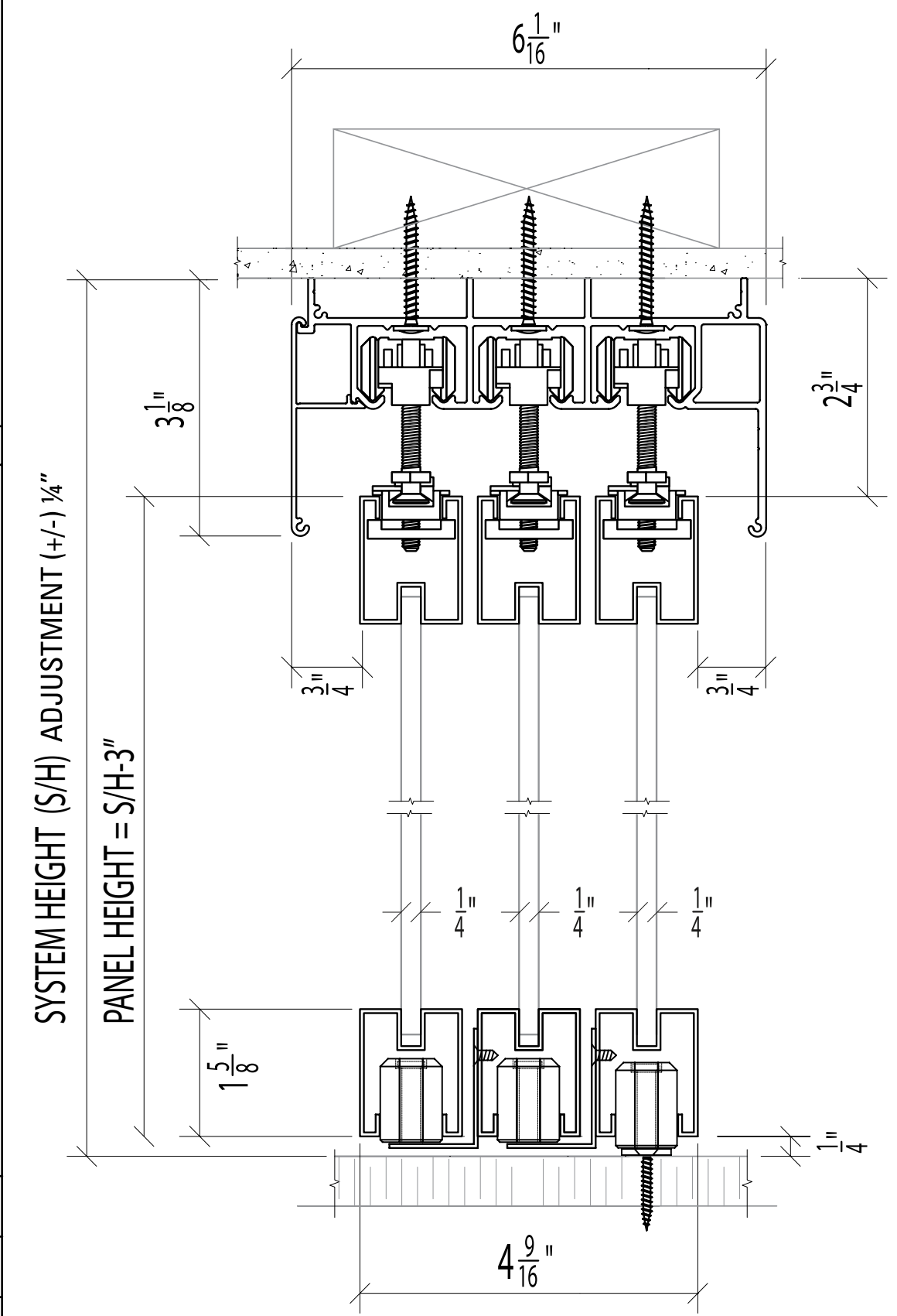

SYSTEM HEIGHT (S/H) ADJUSTMENT (+/-) 1/4"
PANEL HEIGHT = S/H-3"

MONACO Mx-TCP*
Triple Track - Vertical Mount - Floor Post with Carrier Post

SHEET:

JOB #:

SYSTEM PARTS

CUSHION CAPTURE ROLLER ASSEMBLY (SHOWN WITH SINGLE TOP TRACK)

SNAP-ON FASCIA

LINE STANDARD STILE

MODERNO
5/8" WIDE STILE WITH D-PULL

SYSTEM 214 2-1/4" WIDE STILE

* FLOOR POST

2 X

CARRIER POST

SYSTEM 214 LOCK **SYSTEM 214** EDGE PULL

- STANDARD INSERTS
- DIFFUSED WHITE LAMI GLASS
 - CLEAR LAMINATED GLASS
 - MIRROR
 - PREFINISHED HARDBOARD
 - MIRROR / HARDBOARD

- SPECIAL INSERTS
- POLAR WHITE GLASS
 - BLACK GLASS
 - CUSTOMER SUPPLIED INSERT
 - DIVISION BARS

DRAWN BY: JL

DATE: 11/01/20

CHECKED BY: DL

Riviera Glass Divider "Collector Blocks" are designed to assist in closing multi-panel sets of sliding door panels by collecting each panel they pass by. When closing the set, the outermost panel will inter-lock with the next panel, and pull it along to its resting position. To re-open, with all required and recommended blocks installed, pushing the outermost panel will collect all panels as a group. Panels will be staggered in the fully open position.

Below you'll find instructions for installing the blocks. Pay close attention to identify your track series (Monaco or Savona), and the correct location and orientation on the panel. Peel and stick the block in place as illustrated, then install self tapping screws to permanently secure. Pre-drilling is not necessary.

IMPORTANT: Read these instructions completely before beginning any installation.

Block Location

Required

Recommended

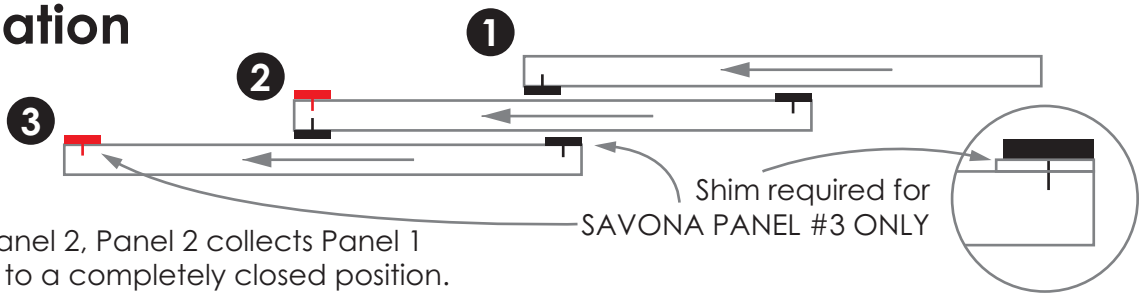

Panel 3 collects Panel 2, Panel 2 collects Panel 1 and pulls them all to a completely closed position.

Block Orientation MONACO

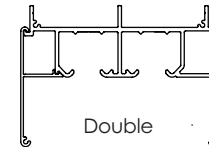

Double

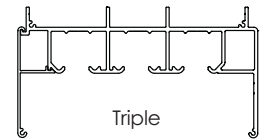

Triple



LONG EDGE of Block
Flush with end of Rail
@ Bottom of Rail

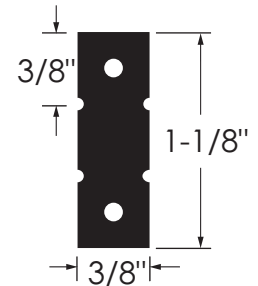
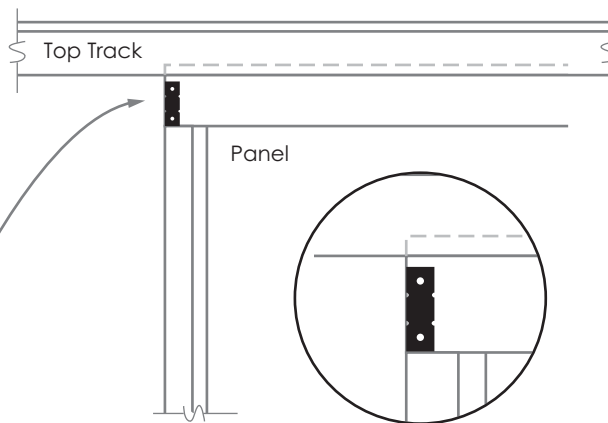

SHORT EDGE of Block
Flush with end of Rail
LONG EDGE @ Bottom
of Rail

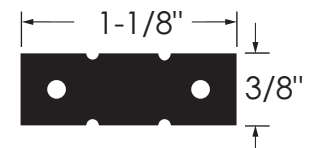
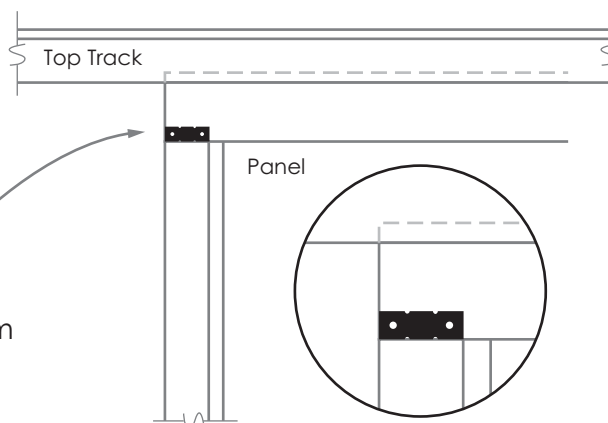

Block Orientation SAVONA

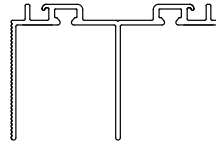

Double

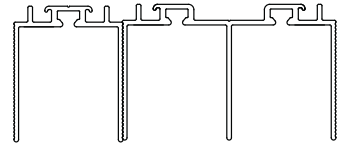

Triple



BREAK OFF BLOCK ENDS
to 3/8" x 3/8" then install
Flush with end of Rail
Bottom of Block @ bottom
of Rail... SHIM PANEL 3 ONLY

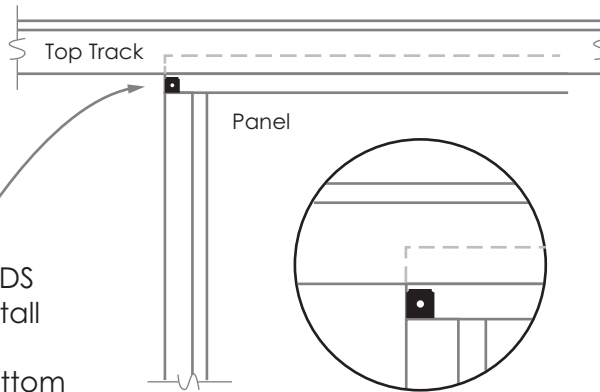

BREAK OFF at notches
to yield 2 Collector blocks
(discard middle section)

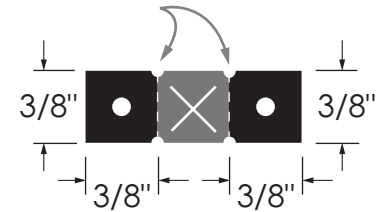

SHORT EDGE of Block
Flush with end of Rail
LONG EDGE @ Bottom
of Rail... SHIM PANEL 3 ONLY

